

BUSBAR SYSTEMS DL

www.eae.com.tr

CONTENTS

Introduction	2-3
Order Code System	4
Technical Characteristics	5
Standard Components	6-7
Special Straight Length	8
Feeder Boxes	9-10
Tap-Off Plugs	11
Tap-Off Boxes and Support Systems	12
DL Joint Installation	13
DL Tap-Off Plug Installation	14
EC Certificate of Conformity	15
Product Specification	16

ELINEDL

►► General Characteristics

E-Line DL Busbar Trunking Systems are used in buildings with an energy requirement between 25A-40A. They are designed to feed lighting fittings due to the characteristics of the 10A-25A tap-off plugs.

EAE Busbar Systems are manufactured using the latest production technologies available worldwide according to ISO 9001 standards with certified Quality Assurance systems. The products are designed and tested in accordance with IEC 60439-2.



Tap-off Plugs

Arrangement of E-Line DL Busbar systems are designed with different contacts to prevent incorrect assembly.

Safety

Earth contacts of the tap-off plugs make first during assembly, and the contact breaks last during disassembly.

Colour Coded Covers Indicate The Phases

The covers of the single phase, 10 Amp, wired tap-off plugs of the EAE DL Lighting busbar systems are designed with different colours to indicate which phase the light fittings are fed.

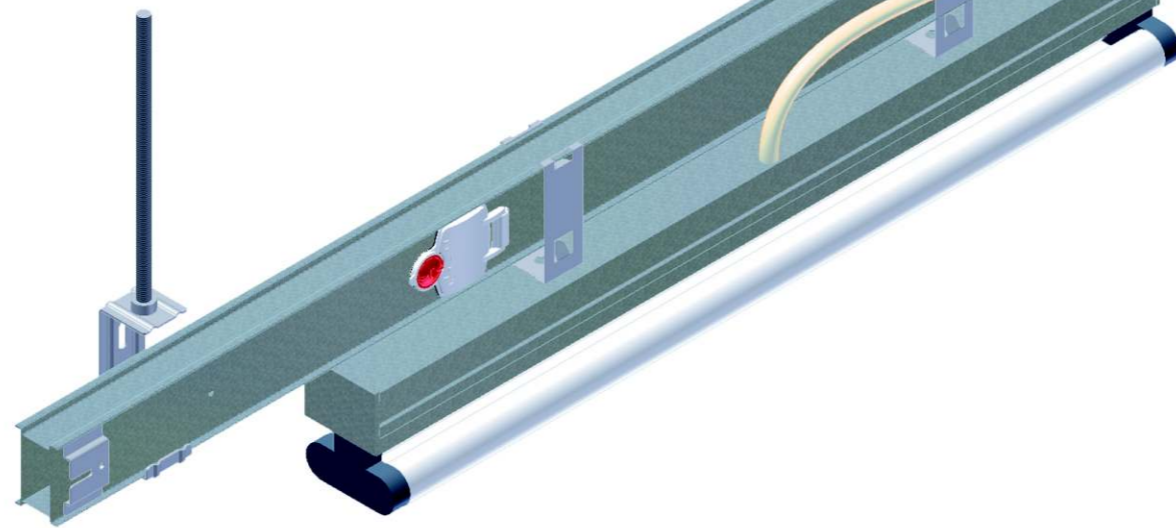

Full Isolation

The busbar conductors are coated in flameproof insulation material. Total security regarding human safety is provided even when the body is severely damaged due to external heavy impacts that may occur.

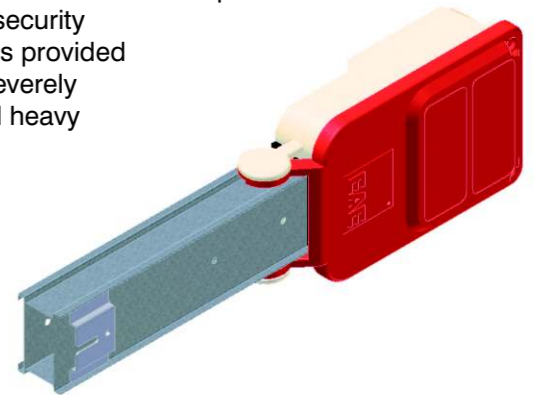

Fast, Easy and Secure Assembly

Provided with single action by driving the mechanical and electrical joint silver coated sprung contacts towards each other. You only need to tighten one bolt to fix the joint.

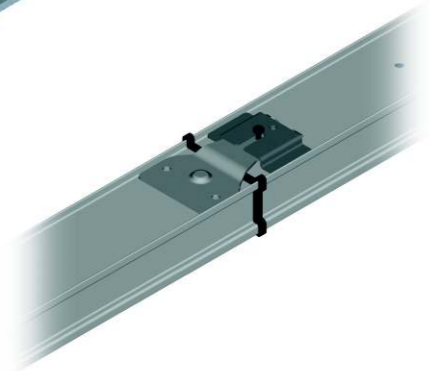

Tin Coated Conductors

Formation of Copper Oxide is prevented by coating the electrolytic copper conductors with full size tin. By this feature, the contact resistances are minimised. The contacts of the tap-off plugs compress the conductor within the busbar from two surfaces.

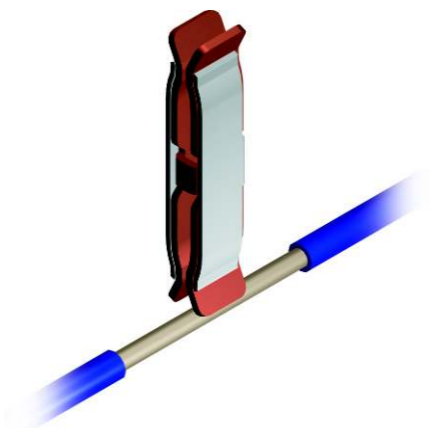

Silver Coated Joint Contacts

The contacts at the joining points of the busbar and the contacts of all tap-off units are silver coated. The silver coating minimises the contact impedances, thus preventing the over-heating of the contacts in case of possible over-loads.

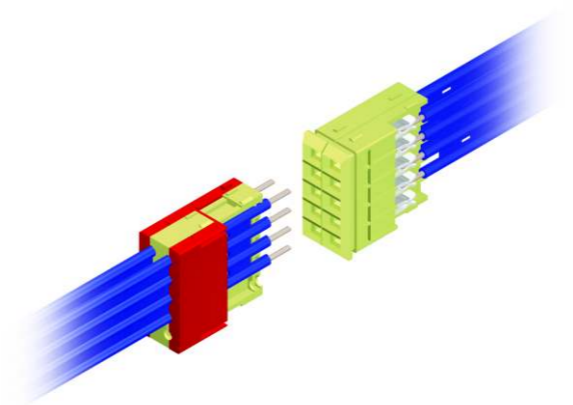

8 Plug-in Points are provided on a Standard 3 m Length

A total of 8 plug-ins on both sides of the busbar is provided as standard.

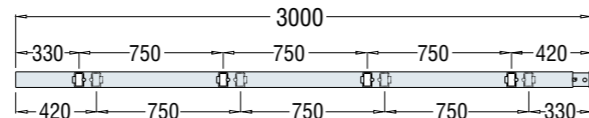

BUSBAR TYPE
 BUSBAR CURRENT RATING 1
 CONDUCTOR CONFIGURATION
 BUSBAR CURRENT RATING 2
 CONDUCTOR CONFIGURATION
 COMPONENT

DL 2 5 2 5 - S T D

Busbar Type

25 A	2
32 A	3
40 A	4

Busbar Current Rating 1

2 Conductors	2
3 Conductors	3
4 Conductors	4
5 Conductors	5

1st Conductor Configuration

25 A	2
32 A	3
40 A	4

Busbar Current Rating 2

2 Conductors	2
3 Conductors	3
4 Conductors	4
5 Conductors	5

2nd Conductor Configuration

Component References

Standard Length	STD
Special Length	X
Feeder Box	B1
End Feeder Box	B2
Underfloor Feeder	B1
Underfloor End Feeder	B2

			DL 2424	DL 3434	DL 4444
Rated Current	In	A	25	32	40
Standards	IEC 60439 1-2				
Rated Insulation Voltage	Ui	V	1000	1000	1000
Rated Frequency	f	Hz 50/60			
Protection Degree	IP 55				
Short-Circuit (1 sn.)	Icw	kA _{rms}	2.50	3.00	4.00
Short-Circuit (Peak)	I _p	kA	4.00	5.00	6.50
Short Circuit(Peak)Tested 1 msec.	kA		21	21	21
Resistance	R ₂₀	m / m	5.42	4.46	2.90
Reactance	X ₁	m / m	2.02	1.62	1.27
Impedance	Z	m / m	5.61	4.47	3.17
Joule Losses At In	I ² R	W / m	3.85	5.24	5.65
L1, L2, L3, N (Cross Section)	mm ²		3.20	4.00	6.00
PE (Housing)	mm ²		18.30	18.30	18.30
PE (Conductor)	mm ²		3.20	4.00	6.00
Weight (4 Conductors)	kg/m		1.40	1.43	1.60
Weight (5 Conductors)	kg/m		1.50	1.55	1.72

The maximum permitted load for the support of light fittings of the system is 15 kg. concentrated or 20 kg. distributed for a recommended support span of every 2 meters without any deformation of the housing.

Voltage Drop Calculation

Voltage drop of a busbar system can be calculated with the following formula taking into account the “ ” load distribution constant.

For single phase;

$$U = .I.2L (R.\cos + X.\sin).10^{-3} [V]$$

For three phase ;

$$U = . 3.I.L (R.\cos + X.\sin).10^{-3} [V]$$

$$U = \text{Voltage Drop } [V]$$

$$I = \text{Rated Current } [A]$$

$$L = \text{Length of Line } [mt]$$

$$= \text{Load Distribution Constant}$$

$$R = \text{Resistance } [m \ m]$$

$$X = \text{Reactance } [m \ m]$$

Load Distribution Constant

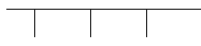
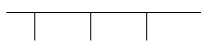
	Load concentrated at the end of line. Line fed from one end of the line.	1.00
	Distributed load. Line fed from one end of the line.	0.50
	Distributed load. Line fed from both ends of the line.	0.25

Pratik Hesap Tablosu

Hesaplar aydınlatmada sık kullanılan = 0.50 için yapılmıştır.

$$U = K.I.L$$

$$k = \text{Gerilim Düşümü Sabiti}$$

$$I = \text{Hat Akımı } [A]$$

$$L = \text{Hat Uzunluğu } [m]$$

ELINEDL

►► Standard Elements

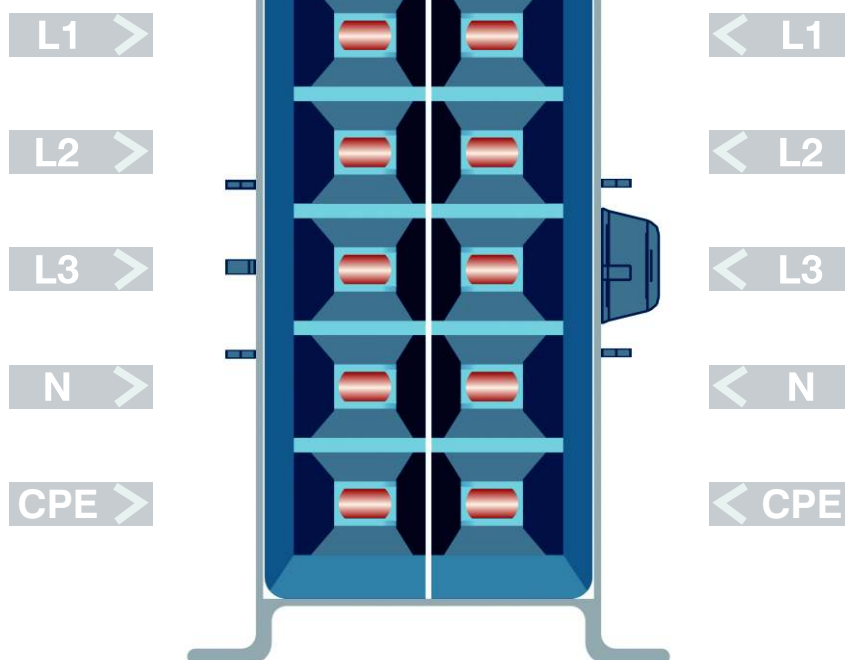
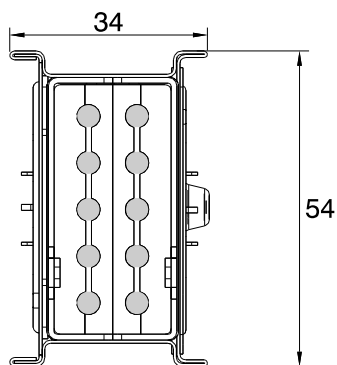
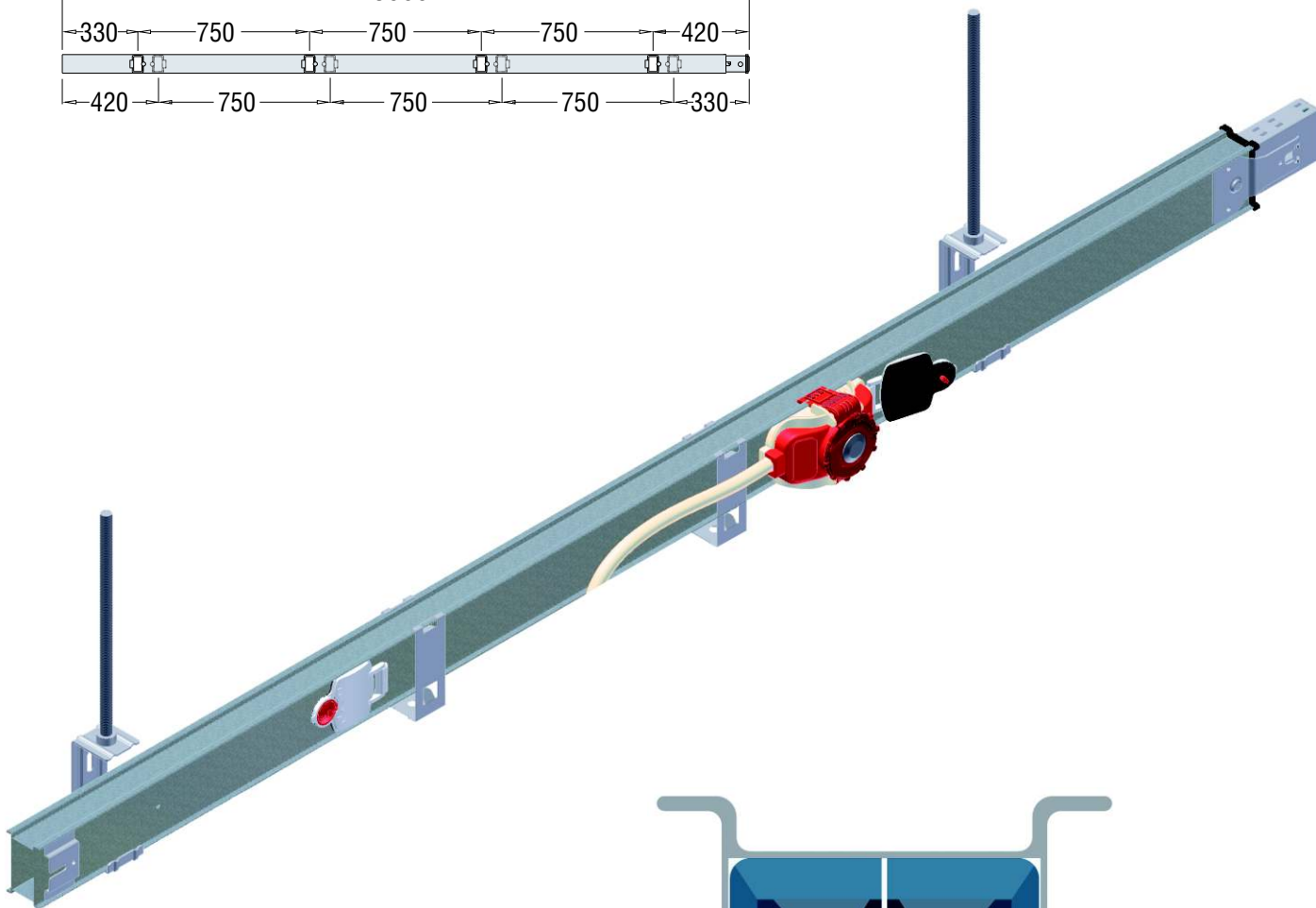
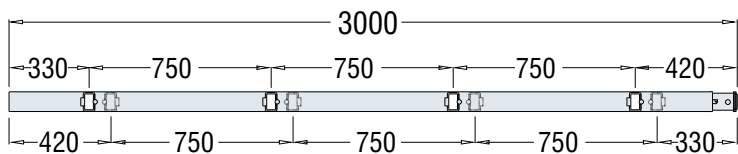

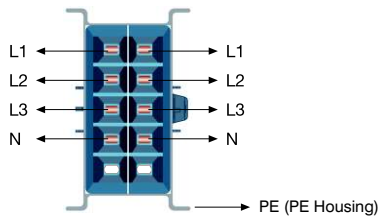

Current (A)	Description	Conductor Conf.	Order Code
25	DL 2424 2x25 A Busbar	4+4	84165
32	DL 3434 2x32 A Busbar	4+4	84167
40	DL 4444 2x40 A Busbar	4+4	84169

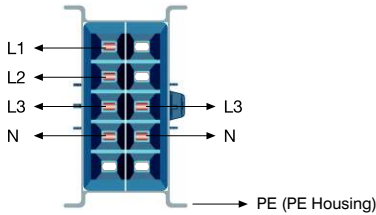

Current (A)	Description	Conductor Conf.	Order Code
25	DL 2422 2x25 A Busbar	4+2	84177
32	DL 3432 2x32 A Busbar	4+2	84179
40	DL 4442 2x40 A Busbar	4+2	84181

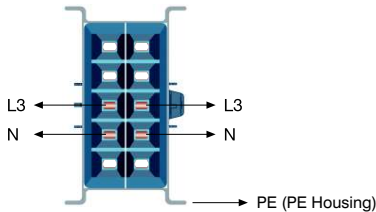

Current (A)	Description	Conductor Conf.	Order Code
25	DL 2222 2x25 A Busbar	2+2	84189
32	DL 3232 2x32 A Busbar	2+2	84191
40	DL 4242 2x40 A Busbar	2+2	84193

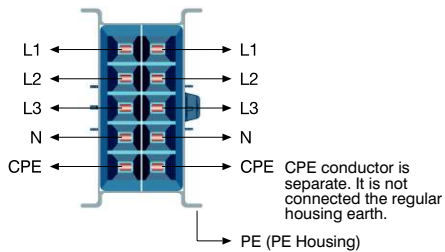

Current (A)	Description	Conductor Conf.	Order Code
25	DL 2525 2x25 A Busbar	5+5	84201
32	DL 3535 2x32 A Busbar	5+5	84203
40	DL 4545 2x40 A Busbar	5+5	84205

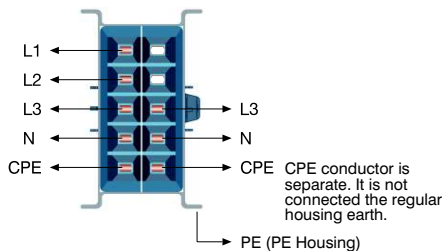

Current (A)	Description	Conductor Conf.	Order Code
25	DL 2523 2x25 A Busbar	5+3	84213
32	DL 3533 2x32 A Busbar	5+3	84215
40	DL 4543 2x40 A Busbar	5+3	84217

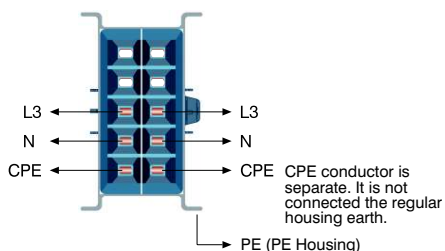

Current (A)	Description	Conductor Conf.	Order Code
25	DL 2323 2x25 A Busbar	3+3	84225
32	DL 3333 2x32 A Busbar	3+3	84227
40	DL 4343 2x40 A Busbar	3+3	84229

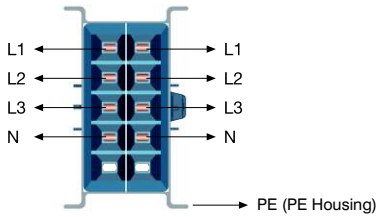

Current (A)	Description	Conductor Conf.	Order Code
25	DL 2424 2x25 A Special Length	4+4	84237
32	DL 3434 2x32 A Special Length	4+4	84239
40	DL 4444 2x40 A Special Length	4+4	84277

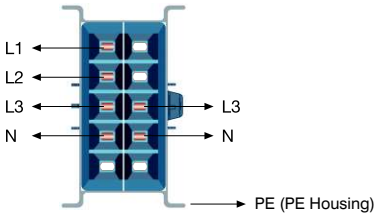

Current (A)	Description	Conductor Conf.	Order Code
25	DL 2422 2x25 A Special Length	4+2	84249
32	DL 3432 2x32 A Special Length	4+2	84251
40	DL 4442 2x40 A Special Length	4+2	84253

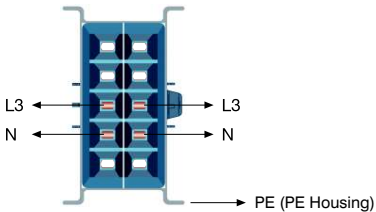

Current (A)	Description	Conductor Conf.	Order Code
25	DL 2222 2x25 A Special Length	2+2	84261
32	DL 3232 2x32 A Special Length	2+2	84263
40	DL 4242 2x40 A Special Length	2+2	84265

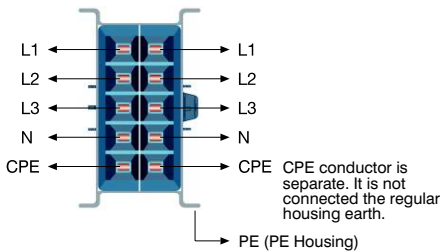

Current (A)	Description	Conductor Conf.	Order Code
25	DL 2525 2x25 A Special Length	5+5	84273
32	DL 3535 2x32 A Special Length	5+5	84275
40	DL 4545 2x40 A Special Length	5+5	84277

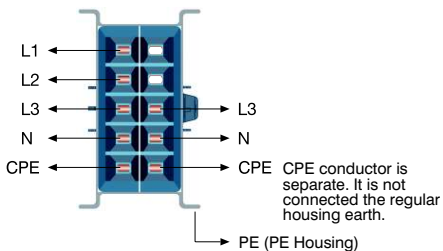

Current (A)	Description	Conductor Conf.	Order Code
25	DL 2523 2x25 A Special Length	5+3	84285
32	DL 3533 2x32 A Special Length	5+3	84287
40	DL 4543 2x40 A Special Length	5+3	84289

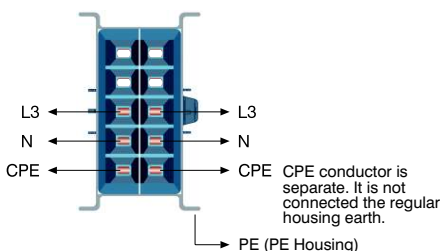

Current (A)	Description	Conductor Conf.	Order Code
25	DL 2323 2x25 A Special Length	3+3	84297
32	DL 3333 2x32 A Special Length	3+3	84299
40	DL 4343 2x40 A Special Length	3+3	84301

■ The body is manufactured from 0,50 mm galvanised sheet metal as standard.

■ For non-standard product, please contact our technical office.

Baştan Besleme

Akım (A)	Açıklama	Uygun Busbarlar	Sipariş Kodu
25	DL 2525 - B1 Baştan Besleme	DL 2525 DL 2523 DL 2323 DL 2424 DL 2422 DL 2222	84345
32	DL 3535 - B1 Baştan Besleme	DL 3535 DL 3533 DL 3333 DL 3434 DL 3432 DL 3232	84347
40	DL 4545 - B1 Baştan Besleme	DL 4545 DL 4543 DL 4343 DL 4444 DL 4442 DL 4242	84349

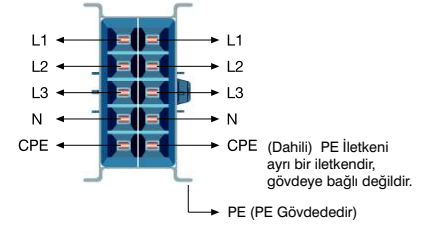
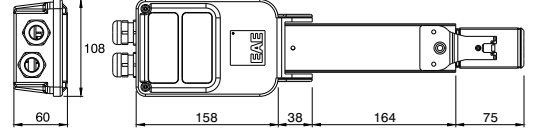

Baştan Besleme

* Standart olarak toprak iletkenli M 25 rakorlu

Sondan Besleme

Akım (A)	Açıklama	Uygun Busbarlar	Sipariş Kodu
25	DL 2525 - B2 Sondan Besleme	DL 2525 DL 2523 DL 2323 DL 2424 DL 2422 DL 2222	84417
32	DL 3535 - B2 Sondan Besleme	DL 3535 DL 3533 DL 3333 DL 3434 DL 3432 DL 3232	84419
40	DL 4545 - B2 Sondan Besleme	DL 4545 DL 4543 DL 4343 DL 4444 DL 4442 DL 4242	84421

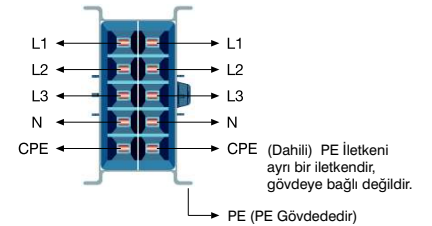
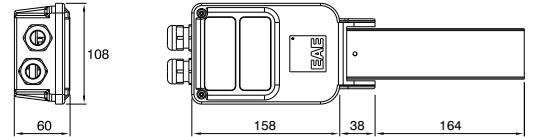

Sondan Besleme

* Standart olarak toprak iletkenli M 25 rakorlu

- Kablo çıkış çapı max Ø 11 mm'dir.
- Gövde standart olarak 0,50 mm galvanizli sacdan imal edilmiştir.
- Standart dışı modüller için lütfen firmamızı arayınız.

Underfloor Feeder Box (Movable Neck)

Current (A)	Description	Busbars	Order Code
25	DL 2525 - B1 Underfloor Feeder Unit	DL 2525 DL 2523 DL 2323 DL 2424 DL 2422 DL 2222	65000
32	DL 3535 - B1 Underfloor Feeder Unit	DL 3535 DL 3533 DL 3333 DL 3434 DL 3432 DL 3232	65004
40	DL 4545 - B1 Underfloor Feeder Unit	DL 4545 DL 4543 DL 4343 DL 4444 DL 4442 DL 4242	65008

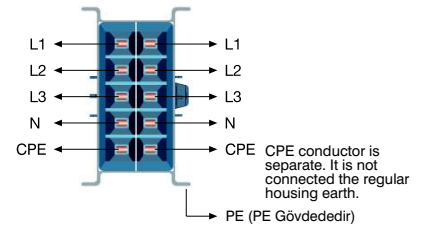
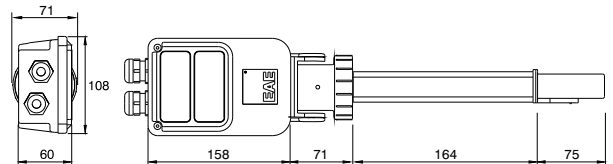
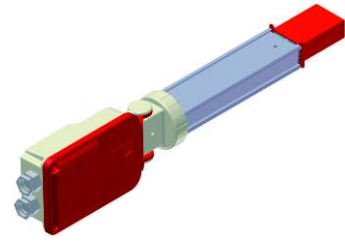

Feeder Box

* With PE Conductor and M25 Gland as standard.
End Closer is supplied together with the feeder unit.

Underfloor End Feeder Box (Movable Neck)

Current (A)	Description	Busbars	Order Code
25	DL 2525 - B2 Underfloor End Feeder Unit	DL 2525 DL 2523 DL 2323 DL 2424 DL 2422 DL 2222	65009
32	DL 3535 - B2 Underfloor End Feeder Unit	DL 3535 DL 3533 DL 3333 DL 3434 DL 3432 DL 3232	65013
40	DL 4545 - B2 Underfloor End Feeder Unit	DL 4545 DL 4543 DL 4343 DL 4444 DL 4442 DL 4242	65017

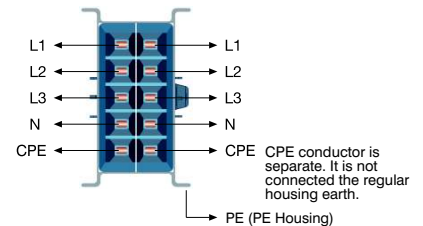
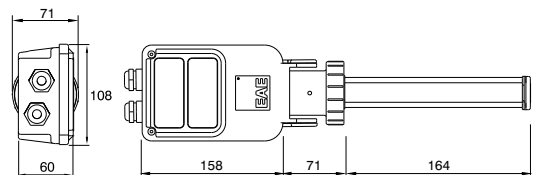
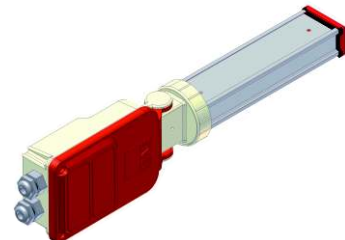

End Feeder Box

* With PE Conductor and M25 Gland as standard.

- Max diameter of feeder cable is Ø 11 mm.
- The body is manufactured from 0,50 mm galvanised sheet metal as standard.
- For non-standard product, please contact our technical office.

Current (A)	Description	Cable Length	Phase	Properties	Order Code
10	DL 10 - B Tap Off Plug L1*	1 m. TTR Cable	L1, N, PE	With Black Cover	84453
	DL 10 - B Tap Off Plug L2*	1 m. TTR Cable	L2, N, PE	With Yellow Cover	84455
	DL 10 - B Tap Off Plug L3*	1 m. TTR Cable	L3, N, PE	With Blue Cover	84457

* Plugs with different length cable available upon request.

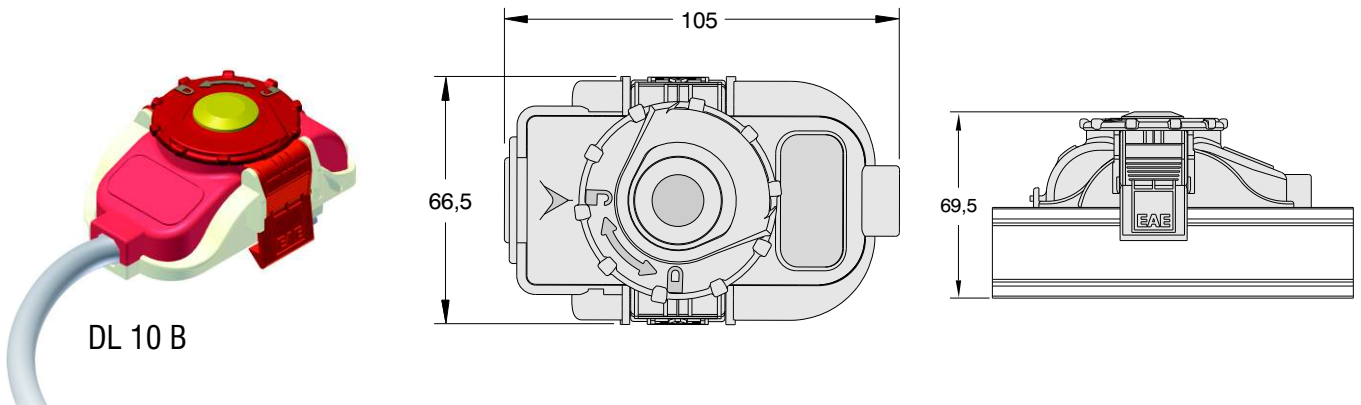

Current (A)	Description	Cable Length	Phase	Properties	Order Code
16	DL 16 - FS Tap Off PlugL1	-	L1, N, PE	With 5 x 20 fuse holders. Max diameter of feeder cable is Ø 11 mm.	84465
	DL 16 - FS Tap Off PlugL2	-	L2, N, PE		84467
	DL 16 - FS Tap Off PlugL3	-	L3, N, PE		84469
	DL 16 - FS Tap Off PlugL123	-	L1, L2, L3, N, PE		84479
16	DL 16 - K Tap Off PlugL1	-	L1, N, PE	Without Fuses. Max diameter of feeder cable is Ø 11 mm.	75013
	DL 16 - K Tap Off PlugL2	-	L2, N, PE		75012
	DL 16 - K Tap Off PlugL3	-	L3, N, PE		75003
	DL 16 - K Tap Off PlugL123	-	L1, L2, L3, N, PE		75001

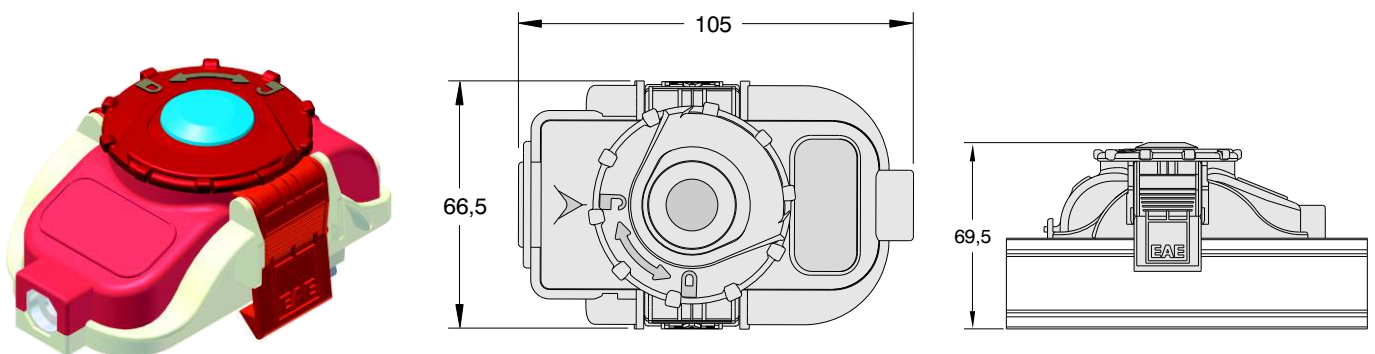

Tap Off Box

Current (A)	Description	Phase	Properties	Order Code
25	DL 25 - S Empty Tap Off Box (CPE)*	L1, L2, L3, N, CPE	5 x 38 fuse holders. Max diameter of feeder cable is Ø 20 mm.	60026
	DL 25 - S Empty Tap Off Box (PE)	L1, L2, L3, N, PE		60027
	DL 25 - S Empty Tap Off Box (2N)	L1, L2, L3, 2N		60028

* Tap off box can be fitted with MCB's of different ratings and brands.

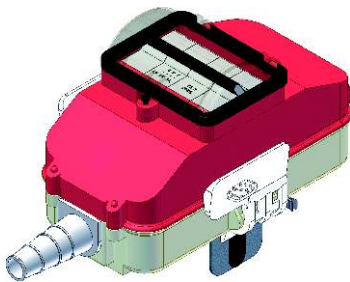

DL 25 - S

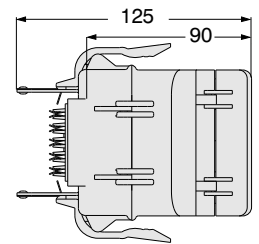
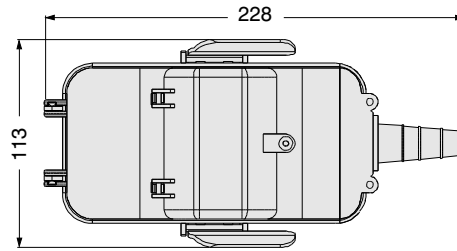

Fixing

Description	Order Code
KA - TP Lighting fixture fixing unit	98525



KA-TP

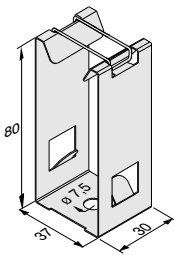

Description	Order Code
KA - TPU Fixing unit "U" type	98699



KA-TPU

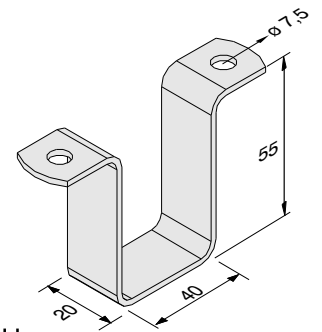

Description	Order Code
KA-TPL Fixing unit "L" type	98698



KA-TPL

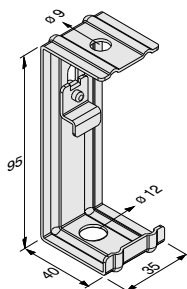

Description	Order Code
DL Fixing Unit	72535



DL-TP

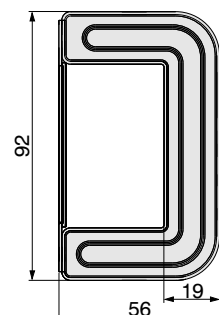

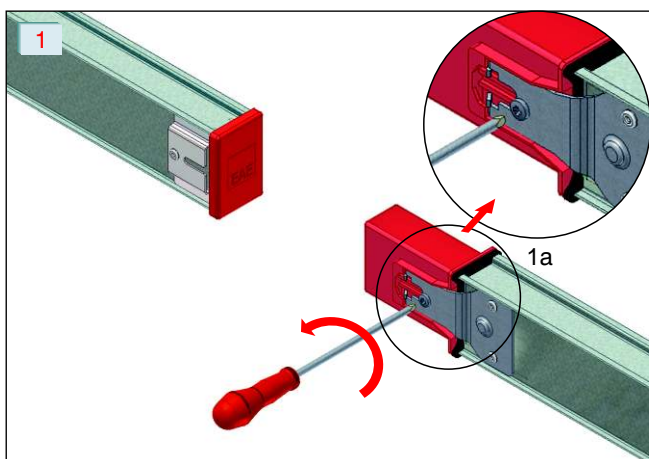

Detach the protective plastic from both ends of the channel. (1a)

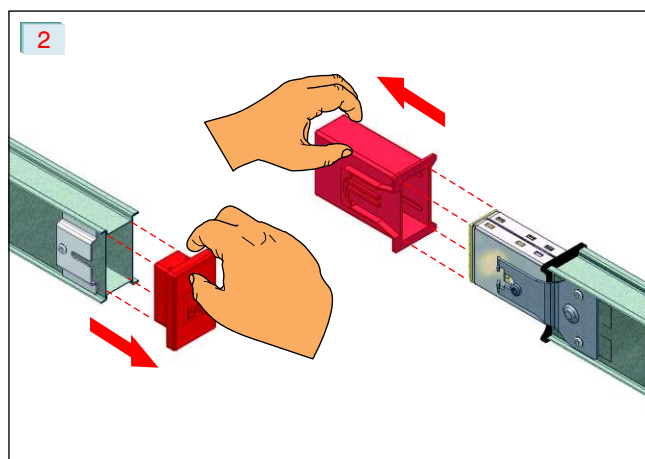

Remove the plastic protective covers from the system as shown in the figure.

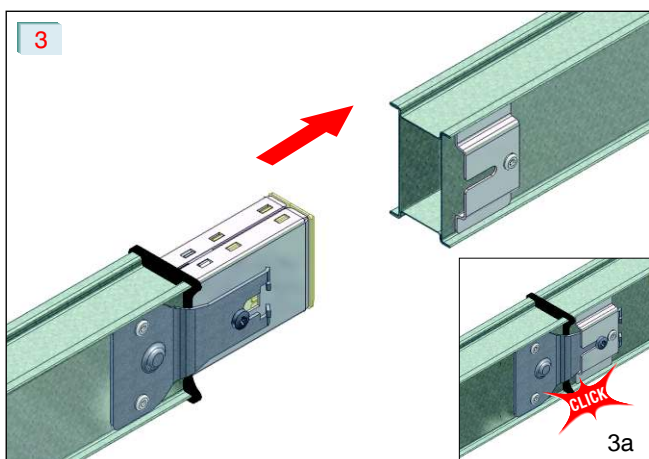

Connect the male side of the channel with the female side of the other channel. Make sure that you hear the locking sound for correct connection. (3a)

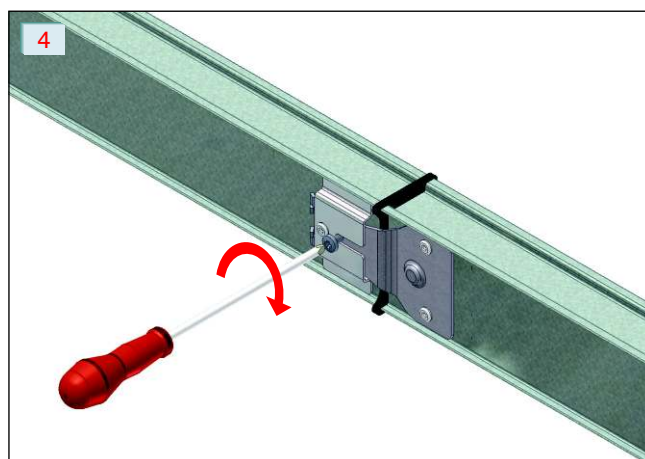

Complete the joint assembly by tightening the joint bolt. (4a)

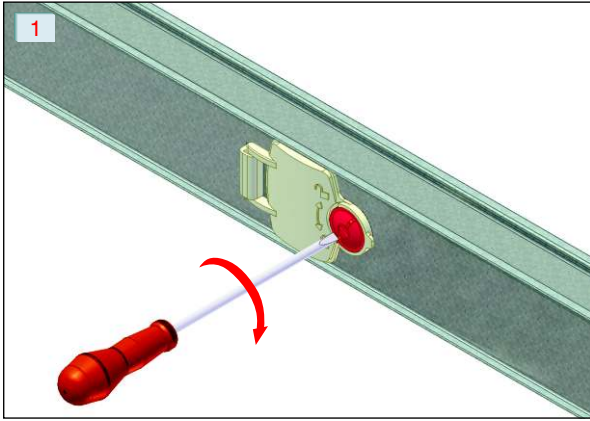

Turn the locking button on the busbar to OPEN (🔓) position (Figure 1).

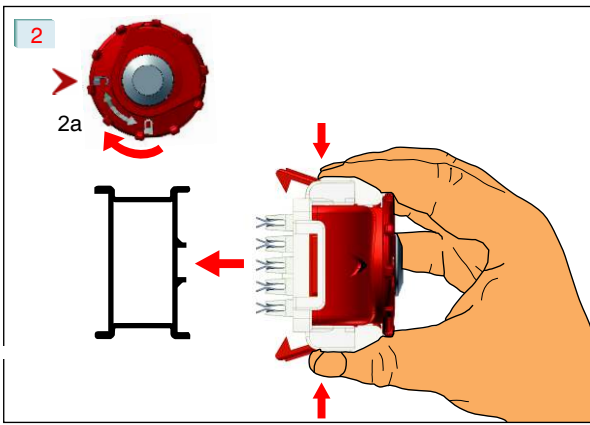

Turn the locking knob to OPEN (🔓) position. Clips are open now. Insert the plug while aligning contacts correctly to the busbar (Figure 2 & 3).

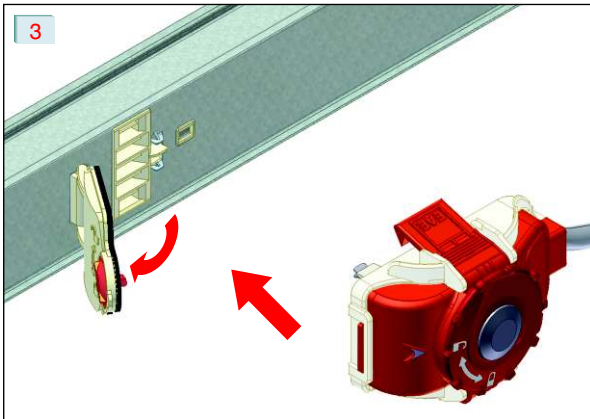

Kontakların yönü bekiideki gibi olmalıdır.

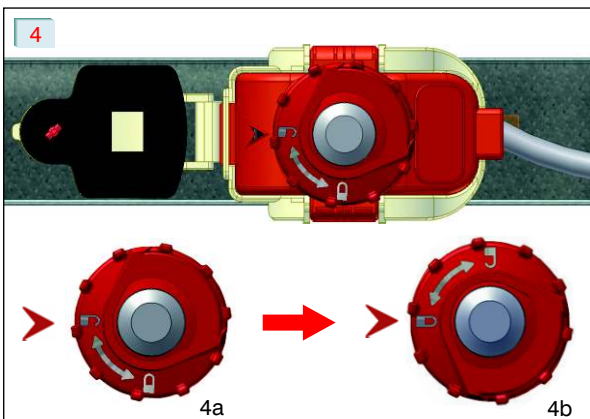

After fixing the plug to the busbar properly, turn the locking knob to LOCK (🔒) position as shown on (Figure 4).

EC DECLARATION OF CONFORMITY

According to EC - Directive

73/23/EEC "Low - Voltage - Directive"

Product Group E-Line DL Busbar Energy Distribution System

Manufacturer EAE Elektrik Asansor End. Insaat San. ve Tic. A.S.
Akcaburgaz Mahallesi, , 119. Sokak,
No:10 34510 Esenyurt-Istanbul

This is to attest, under our sole responsibility, that the aforementioned products conforms with the regulations and guidelines of the following standards.

Standard : IEC 60439-1
IEC 60439-2

Type Tests

- | | |
|---|--|
| 1- Temperature Rise | 7- Protection Class |
| 2- Dielectric Characteristics | 8- Electrical Characteristics |
| 3- Short Circuit Resistance | 9- Structural Strength |
| 4- Continuity of the Protective Circuit | 10- Crush Strength |
| 5- Creepage Distances | 11- Insulation Material Thermal Strength |
| 6- Mechanical Operation | |

Date

09 January 2008

EAE Elektrik A.Ş.**EAE Elektrik Asansor End. Insaat San. ve Tic. A.S.**

Akcaburgaz Mahallesi, 119. Sokak, No:12 34510 Esenyurt-Istanbul-Turkey
Tel: +90 (212) 866 20 00 Fax: +90 (212) 886 24 20 <http://www.eae.com.tr>

25-32-40A PLUG-IN BUSBAR SYSTEMS PRODUCT SPECIFICATION (E-Line DL)

- 1- The manufacturer of the busbar systems shall have ISO 9001 and ISO 14001 certification and busbar systems shall be type tested and certified according to IEC 60439-2 by international laboratories.
- 2- The rated insulation voltage of the system shall be 1000V.
- 3- The busbar system shall have rated current levels between 25A and 40A and shall have tin plated copper conductors
- 4- The conductors in the housing shall be continuously insulated and only peeled off at the plug-in points to create contact area.
- 5- The busbar system shall conform to the following phase configuration.
 - a) 2 Conductors : L1 / N / Housing (Earthing)
 - b) 3 Conductors : L1 / N / PE + Housing (PE conductor and housing are not connected)
 - c) 4 Conductors : L1 / L2 / L3 / N / Housing (Earthing)
 - d) 5 Conductors : L1 / L2 / L3 / N / PE + Housing (PE conductor and housing are not connected)
Housing shall be used as earth conductor.
- 6- A total of 8 plug-in points on the standard 3 m length of the busbar system. It shall be possible to increase the number of windows on request. Protective covers shall be provided on plug-in windows.
- 7- There shall be insulator supports at the plug-in points
- 8- The conductors shall be of electrolytic copper and continuously tin plated
- 9- Joint of the busbar shall slide into each other; joint contacts shall be silver plated. To ensure a safe joint contact there shall be springs on both sides of joint contacts.
- 10- IP Protection degree of the busbars shall be 55
- 11- The housing of the busbar shall be manufactured of 0,50 mm thick galvanised sheet metal. It shall be possible for the manufacturer to produce in Ral 7038 coloured electrostatic oven-dried paint finish when requested.
- 12- Contacts in the tap offs shall be of the jawed construction, which contact the conductors on both sides. The contacts shall also have steel springs.
- 13- Standard support fittings and fixing components suitable for the external structure of the busbar system shall be provided and shall be produced by the manufacturer.



E-LINE KB

Compact Busbar Distribution System
800...6300A



E-LINE KO

Plug-in Busbar Distribution System
160...800A



E-LINE MK

Small Power Plug-in Busbar Distribution System
100-160-225A



E-LINE KAP

Plug-in Busbar Distribution System
40-63A



E-LINE DL

Multi-conductor Lighting Busbar System
25-32-40A



E-LINE KAM

Lighting Busbar System
25-32-40A



E-LINE TB

Multi Conductor Trolley Busbar System
35...250A

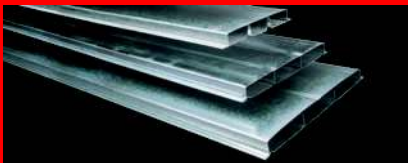

E-LINE DK

Underfloor Ducting Systems



E-LINE DKY

Raised Floor Energy Distribution Systems
25...63A

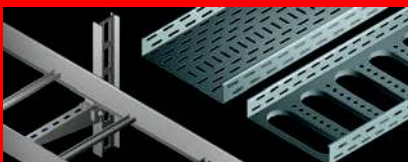

E-LINE UK

Cable Tray and Ladder Rack Systems

